

平面図

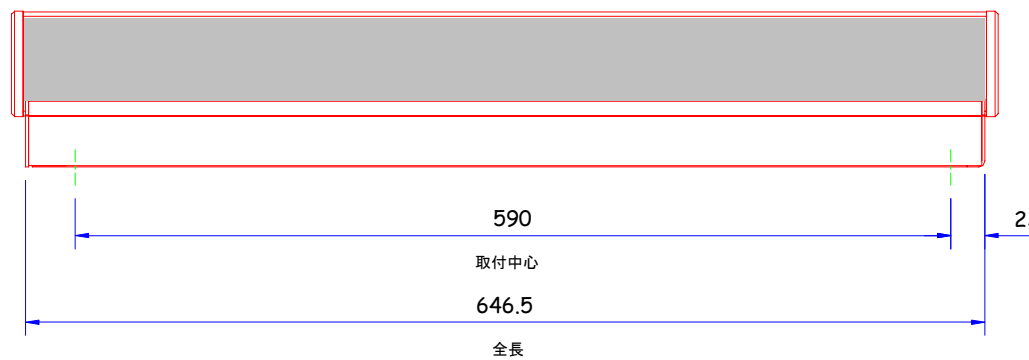

正面図



側面図

製品名:	Fastlane Door Detective CL
図名称:	外形寸法図
IDL社図面番号	DRAWING No: S665_420_A0
DATE: 08.2.20	This document is the copyright of Integrated Design Ltd

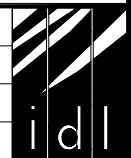

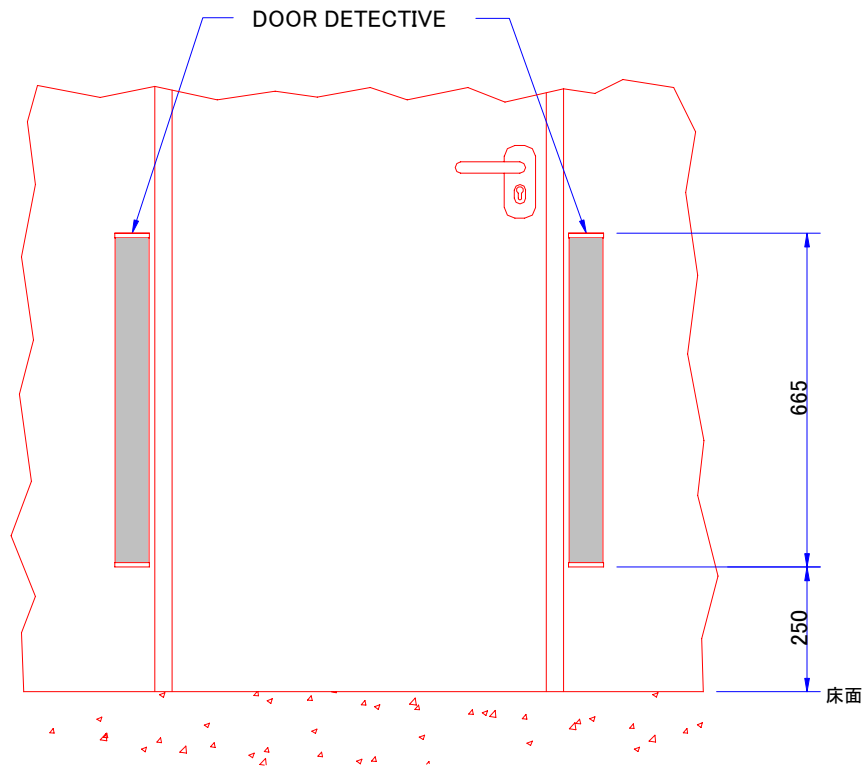

正面図

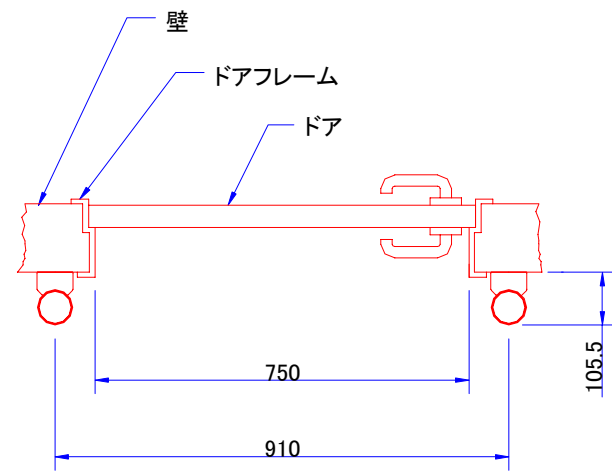

平面図

製品名:	Fastlane Door Detective CL
図名称:	設置図(ドアマウント)
IDL社図面番号	DRAWING No: S665_421_A0
DATE: 08.2.20	This document is the copyright of Integrated Design Ltd

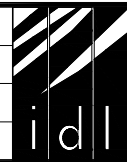

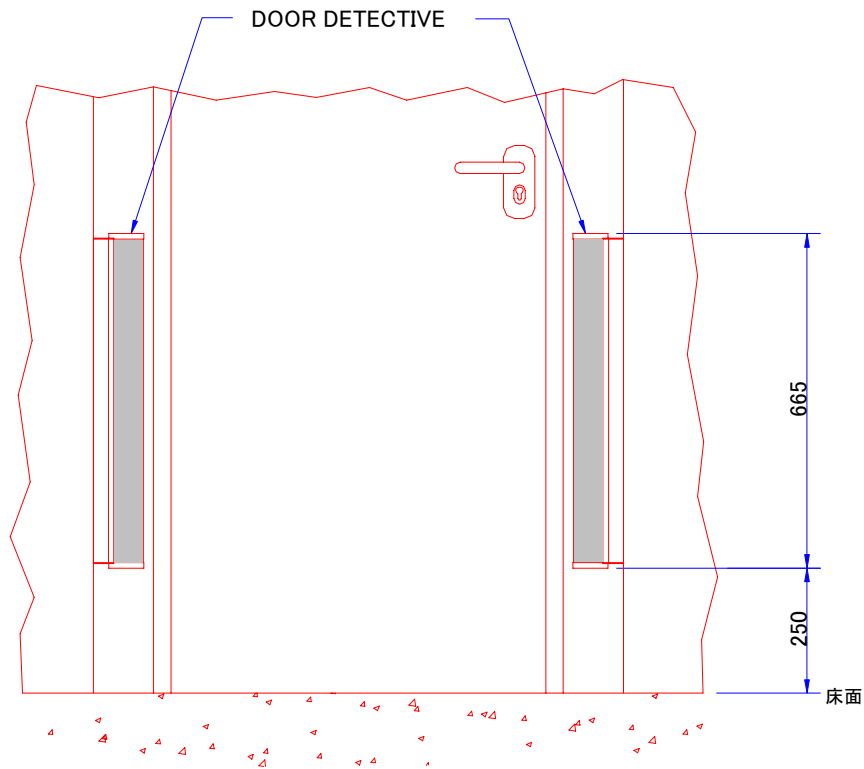

正面図

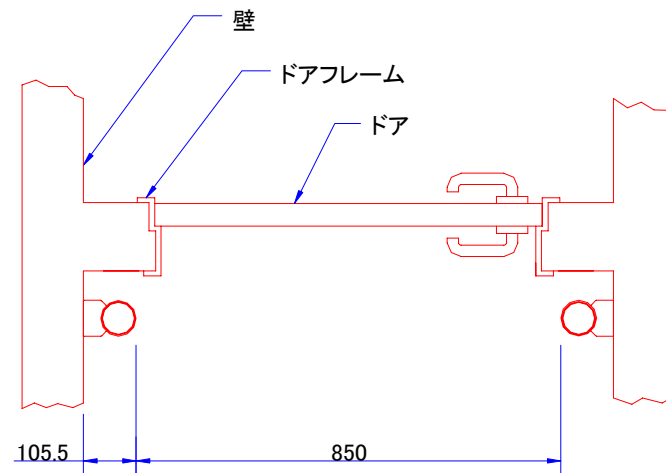

平面図

製品名:	Fastlane Door Detective CL
図名称:	設置図(壁マウント)
IDL社図面番号	DRAWING No: S665_422_A0
DATE: 08.2.20	This document is the copyright of Integrated Design Ltd

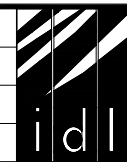

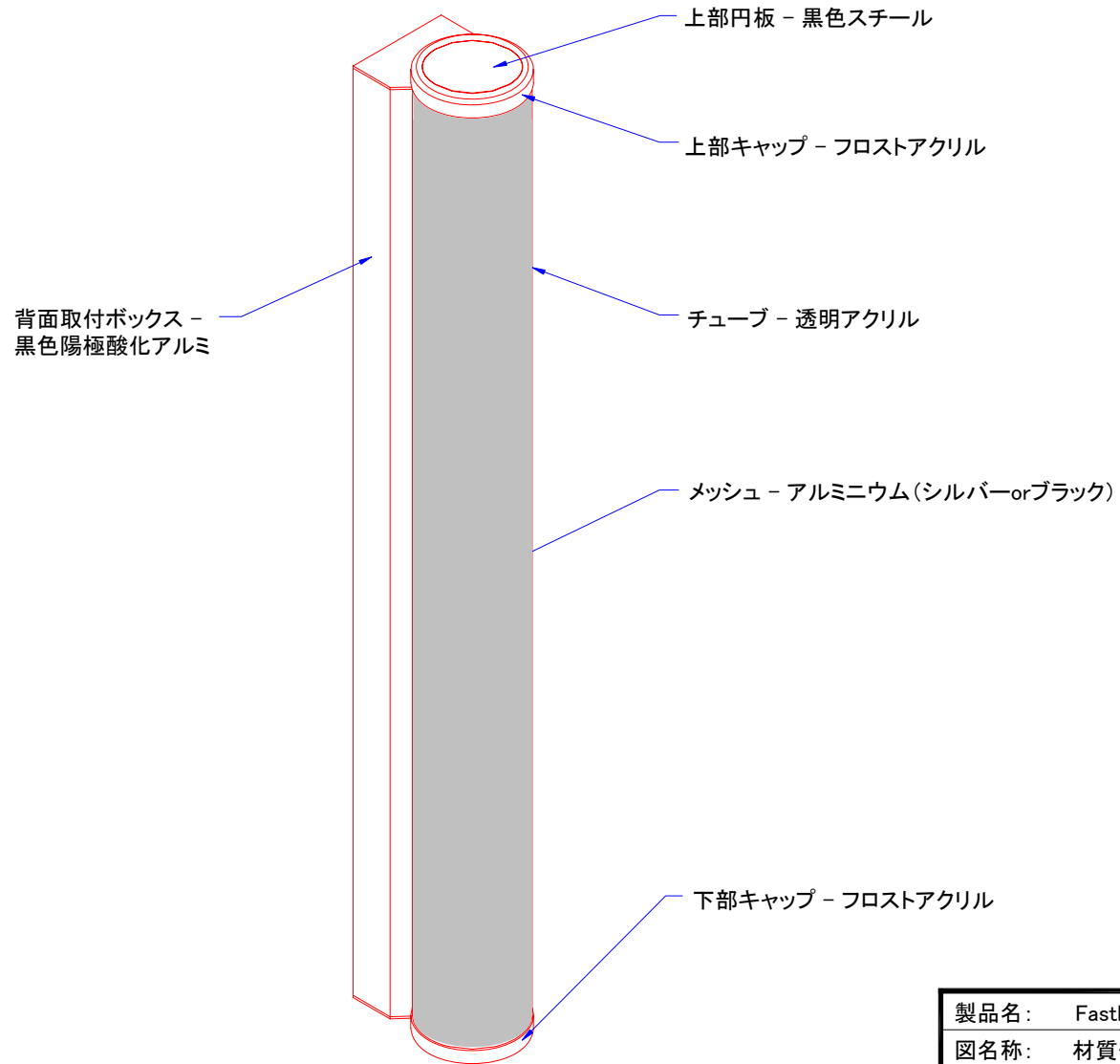

製品名:	Fastlane Door Detective CL
図名称:	材質仕様
IDL社図面番号	DRAWING No: S665_423_A0
DATE: 08.2.20	This document is the copyright of Integrated Design Ltd

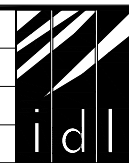

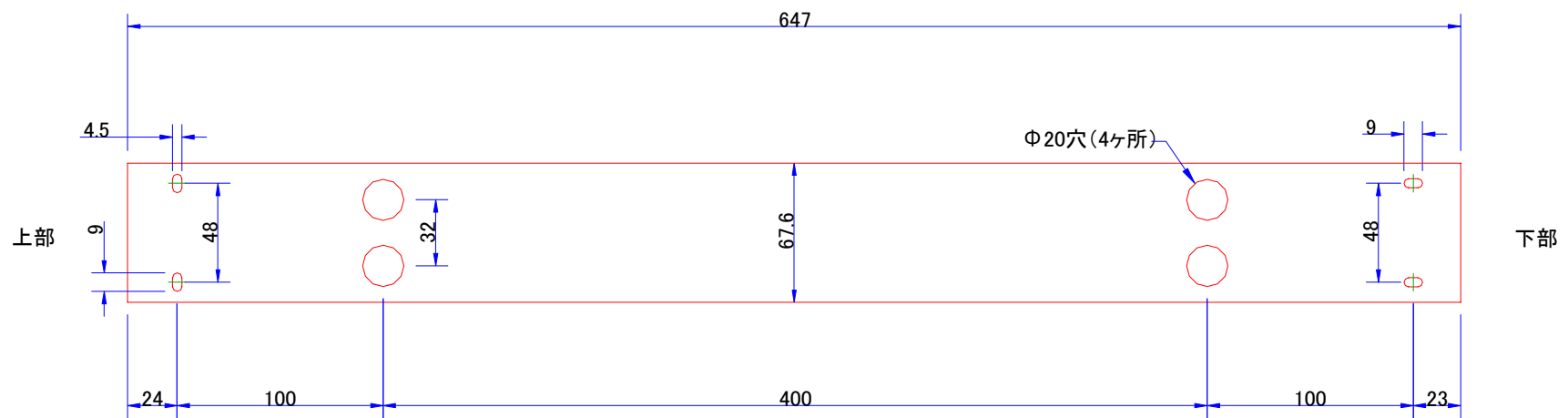

製品名: Fastlane Door Detective CL	
図名称: 背面図(取付寸法)	
IDL社図面番号	DRAWING No: S665_424_A0
DATE: 08.2.20	This document is the copyright of Integrated Design Ltd

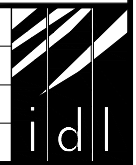

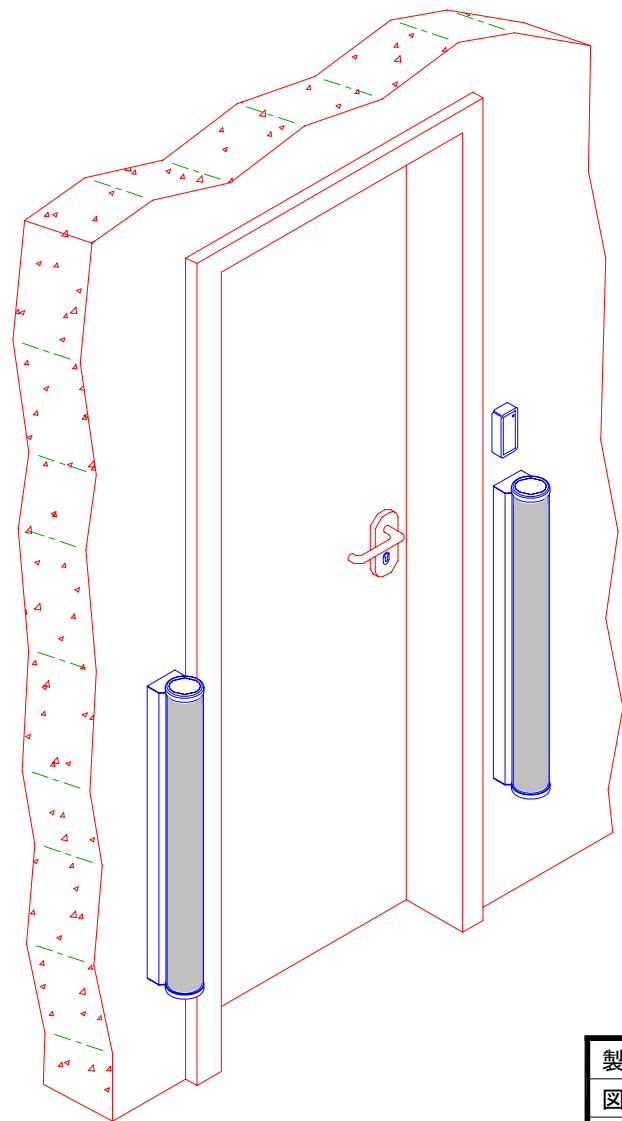

製品名:	Fastlane Door Detective CL
図名称:	設置例
IDL社図面番号	DRAWING No: S665_425_A0
DATE: 08.2.20	This document is the copyright of Integrated Design Ltd

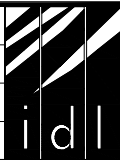

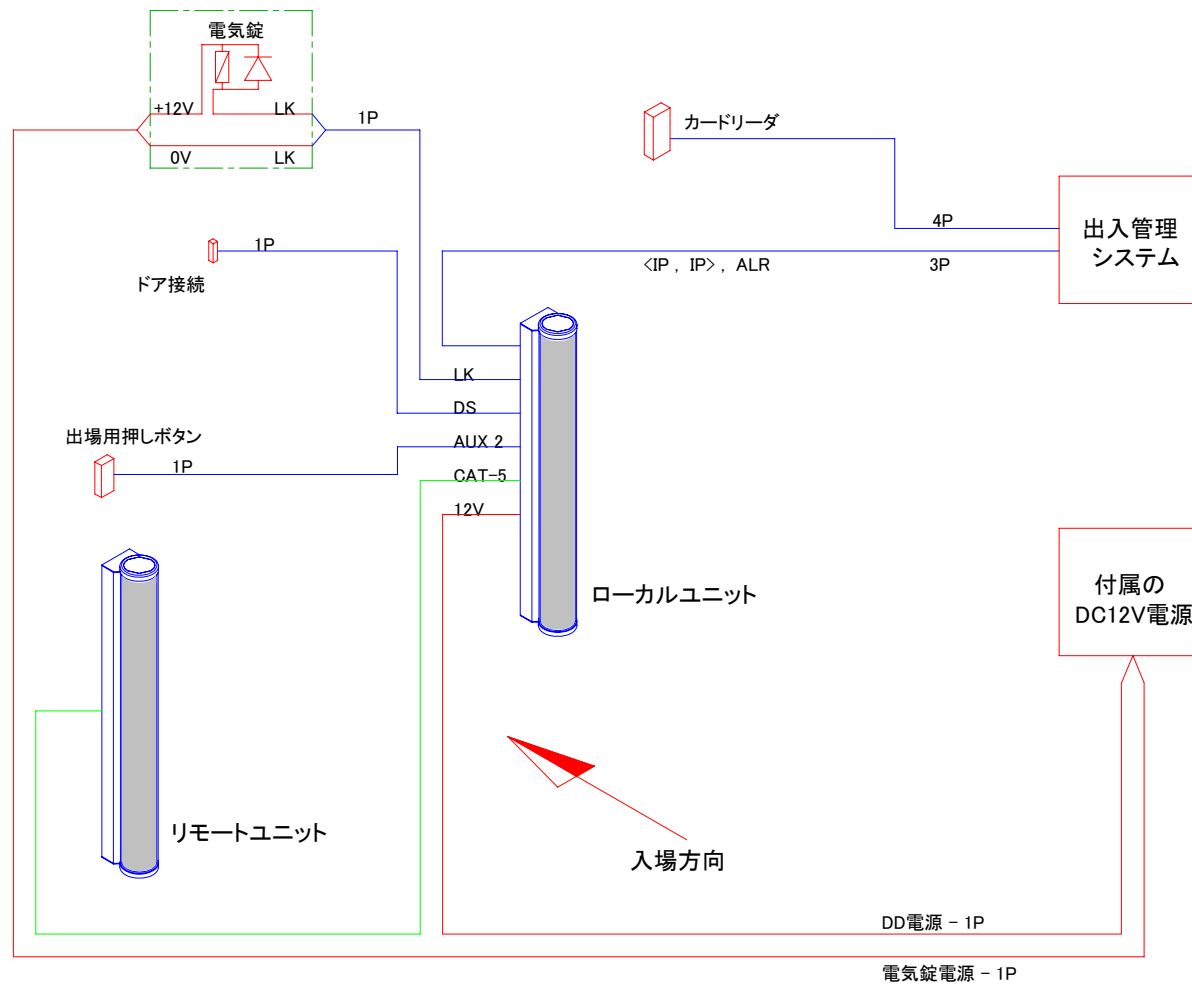

製品名:	Fastlane Door Detective CL
図名称:	配線図
IDL社図面番号	DRAWING No: S665_426_A0
DATE: 08.2.21	This document is the copyright of Integrated Design Ltd

